

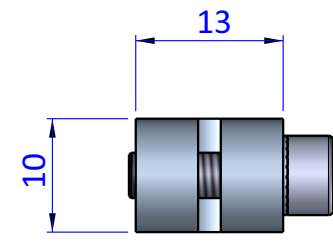

THE PROPERTY OF THE DRAWING IS ESTABLISHED BY LAW. IT IS FORBIDDEN TO PRODUCE OR SHOW IT TO THIRD PART. WITHOUT A WRITTEN AGREEMENT.

Item	Name	Q.ty
1	GLA.10.1.30	1
2	GLA.10.2	1
3	R.4.SCH	3
4	V.TCE4x12	1
5	V.TCE4x14	1

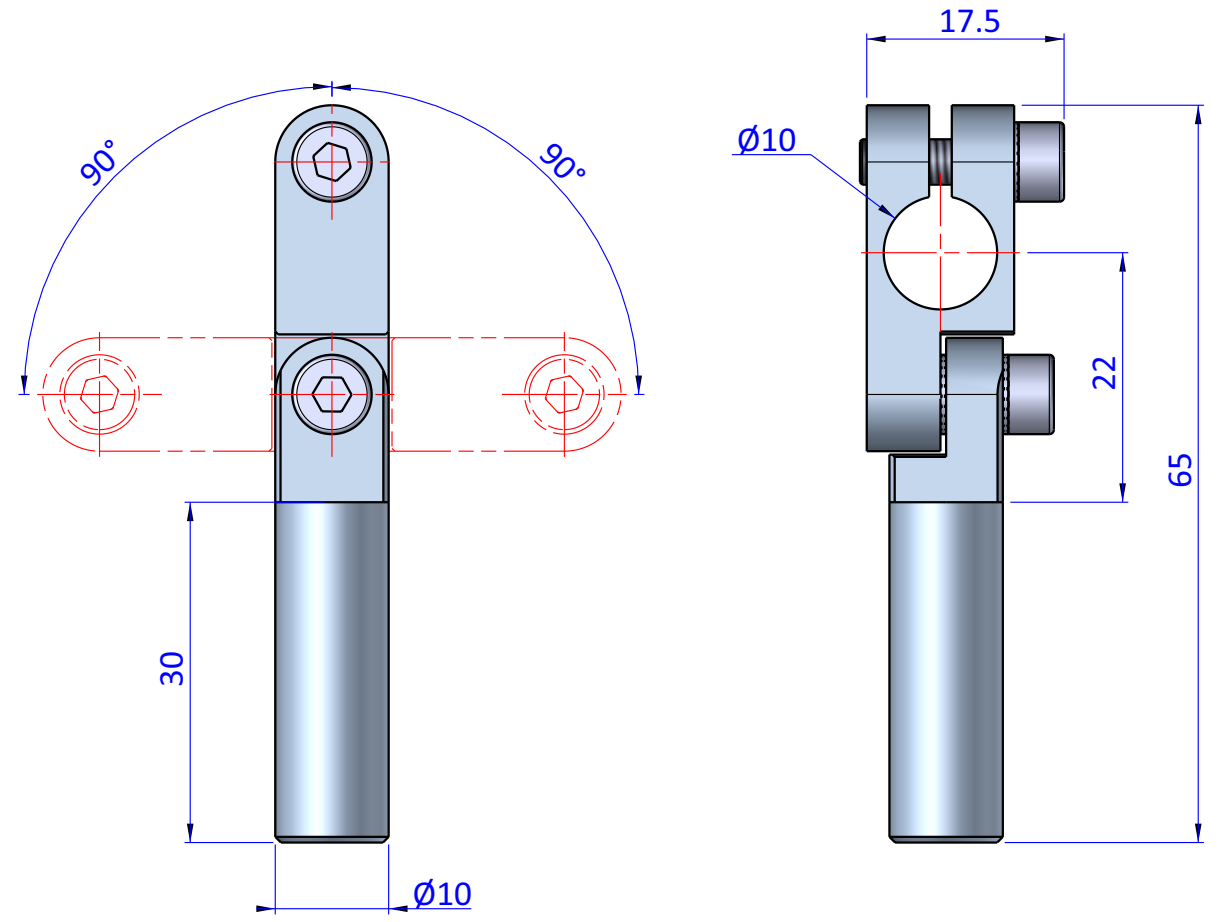
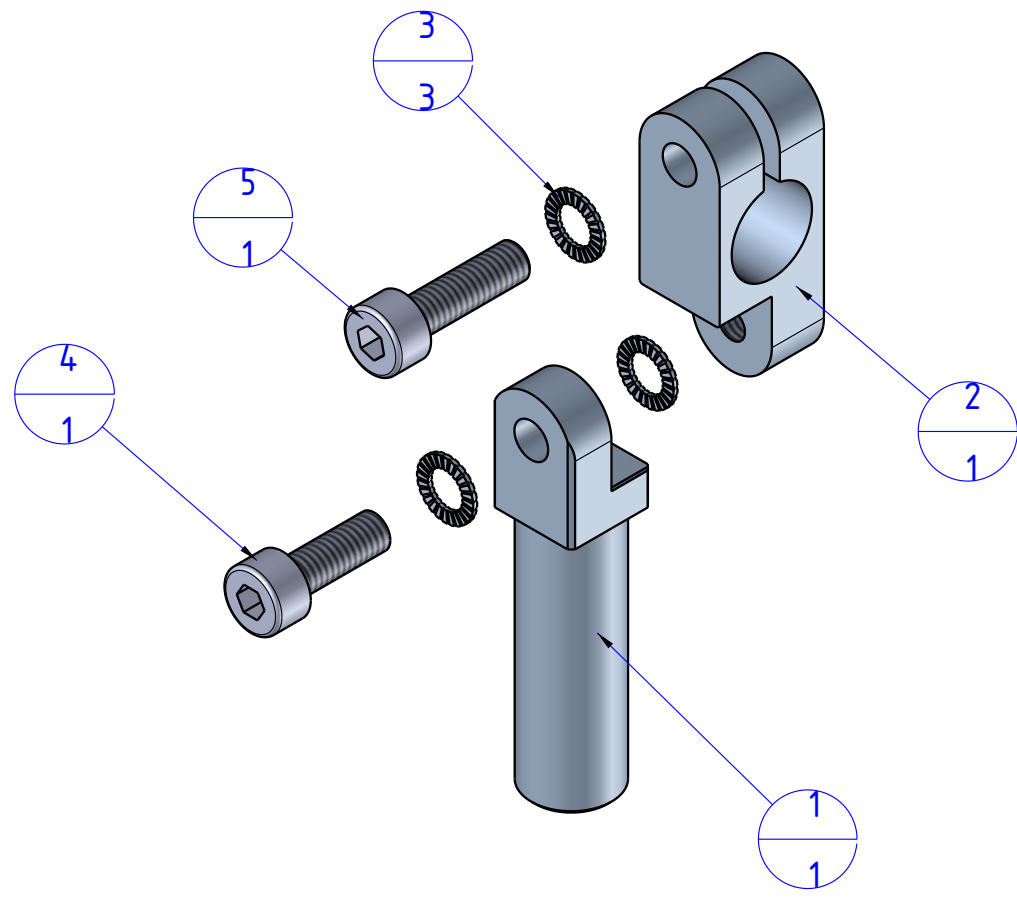

Format A3
UNI 936-76

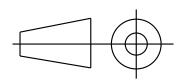
 FPS FPSERVICES AUTOMATION			DESIGNED FROM FPS Automation	REVIEW A
GENERAL TOLERANCE UNI - ISO 2768 CLASSE f	DESCRIPTION CA.GLA.1010.30		DATE 24/08/2020	WEIGHT 0,016kg
			CODE CA.GLA.1010.30	